

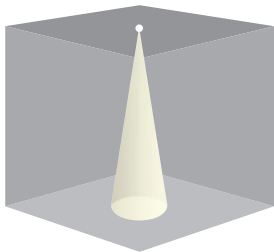

The Pinnacle of Performance and Precision
1", 2", 3", 4" LED RECESSED DOWNLIGHT

PERFORMANCE

The Acrobat recessed lighting system is the ultimate performer, engineered to deliver premium light quality and control in any application, to the most exacting standard.



10° Spot

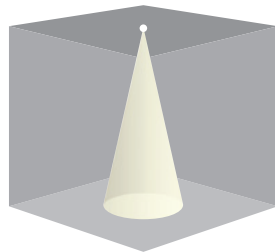

30° Narrow Flood

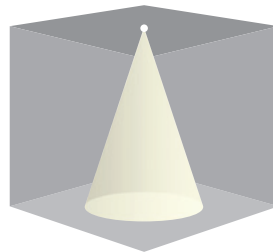

50° Flood

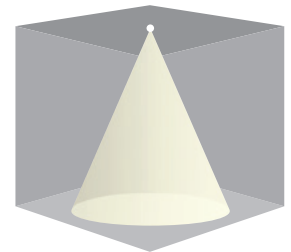

80° Wide Flood

PRECISION

Acrobat's light module installs separately from the housing, at the end of construction. It easily adjusts up or down, independent of the housing, to guarantee a tight fit between the optic holder and the reflector to hide internal components and maintain a professional, clean look below the ceiling.

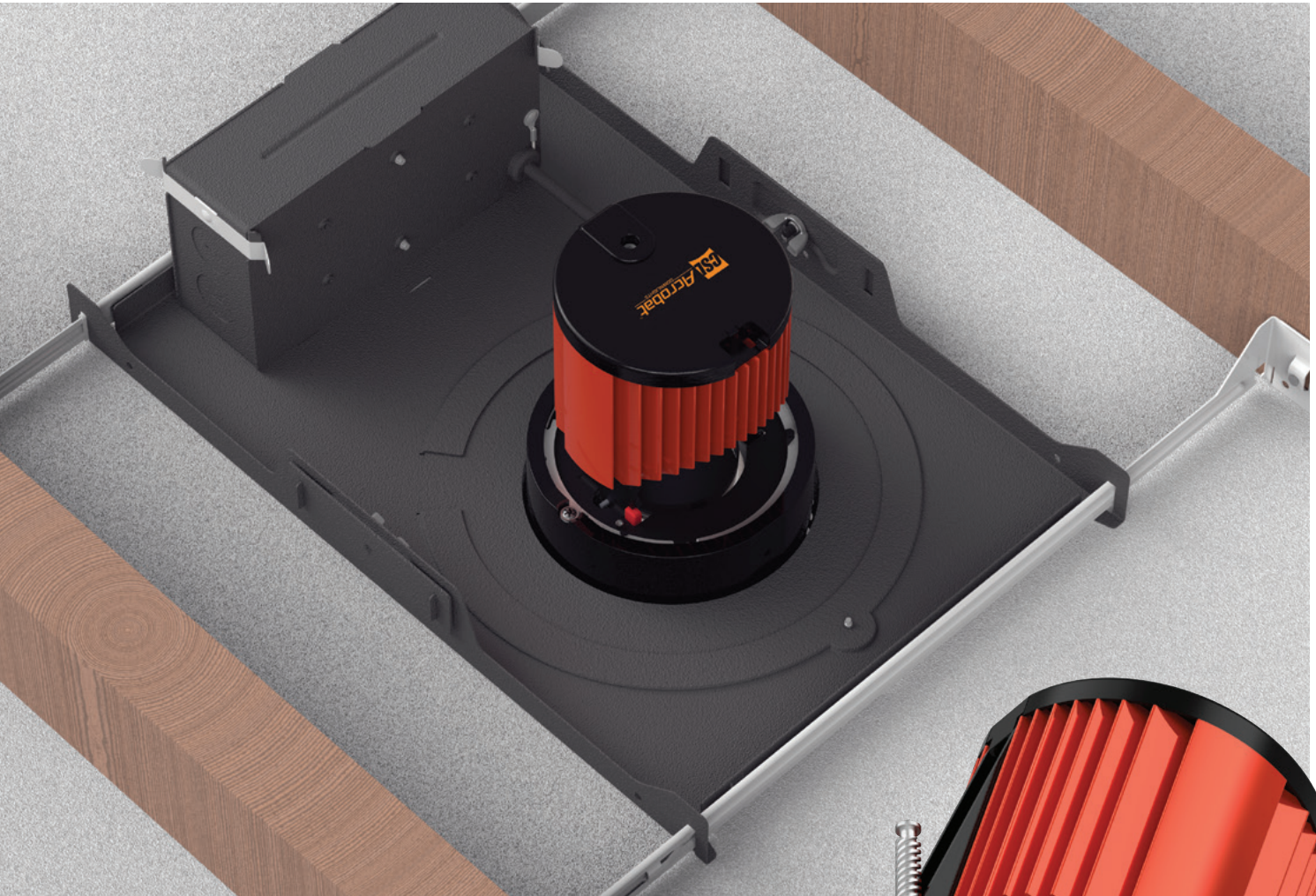

BELOW CEILING ADJUSTMENT
Lead Screw

Adjustability is quick, easy, and precise. The light module rotates 360°. A twist of the custom lead screw tilts the module to the desired degree and locks it in place.



Fixed

Adjustable

Wall Wash



DESIGN

Acrobat LED modules house CSL's patented Silent Vu™ optics, a unique system that converges light output through the optic to provide quality light with minimal glare.

REFLECTOR

Round or Square Shape

Standard, Pinhole, Slot Pinhole, Wall Wash, Adjustable Lensed Style

White, Black, Champagne, Satin Aluminum, Clear Alzak Finish

MEDIA

Clear Lens, Solite Lens,

Frosted Lens, Linear Spread Lens

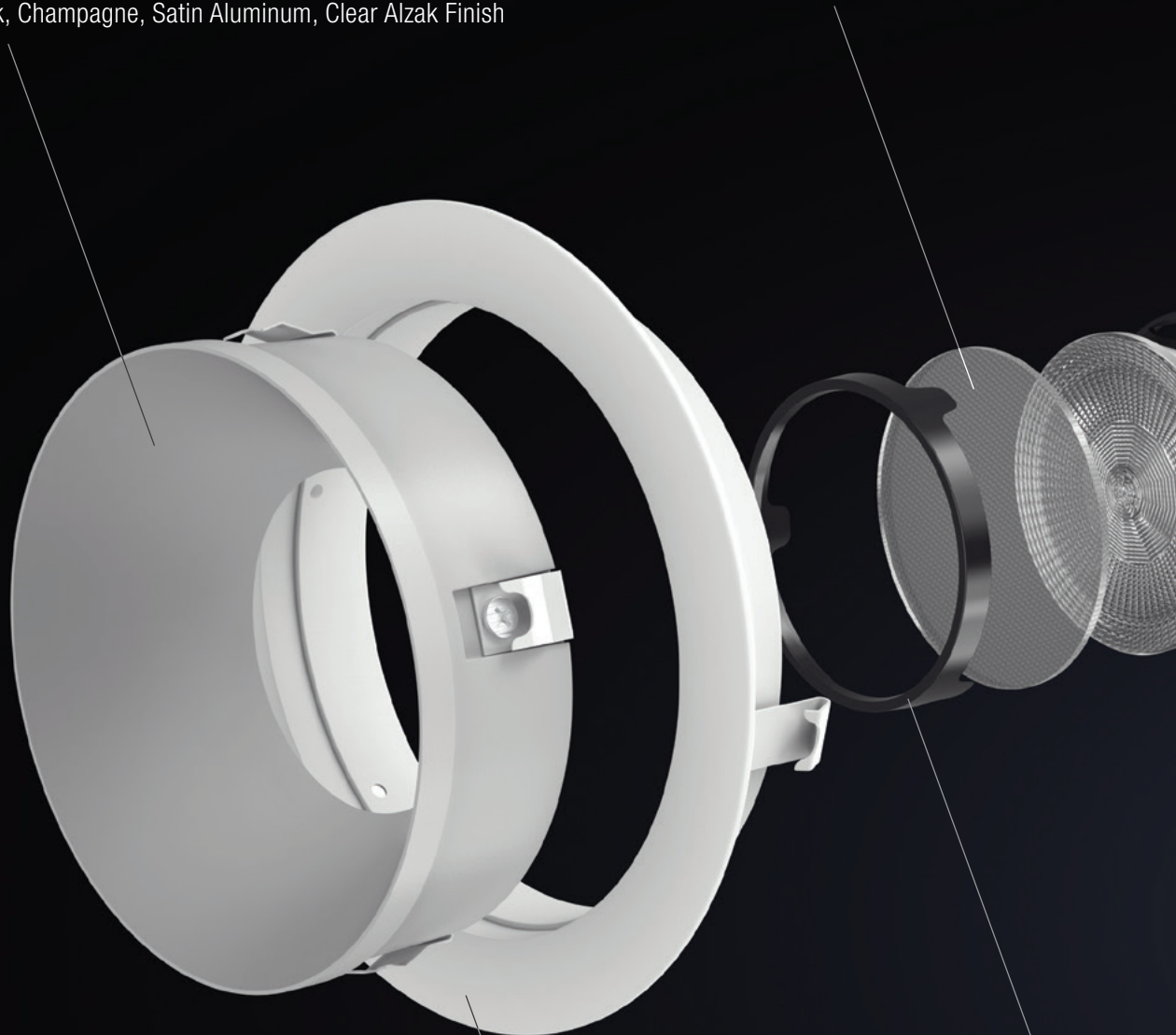

TRIM

Round or Square Shape

Standard, Trimless, Wood Ceiling Style

White, Black, Champagne, Satin Aluminum Finish

MEDIA HOLDER

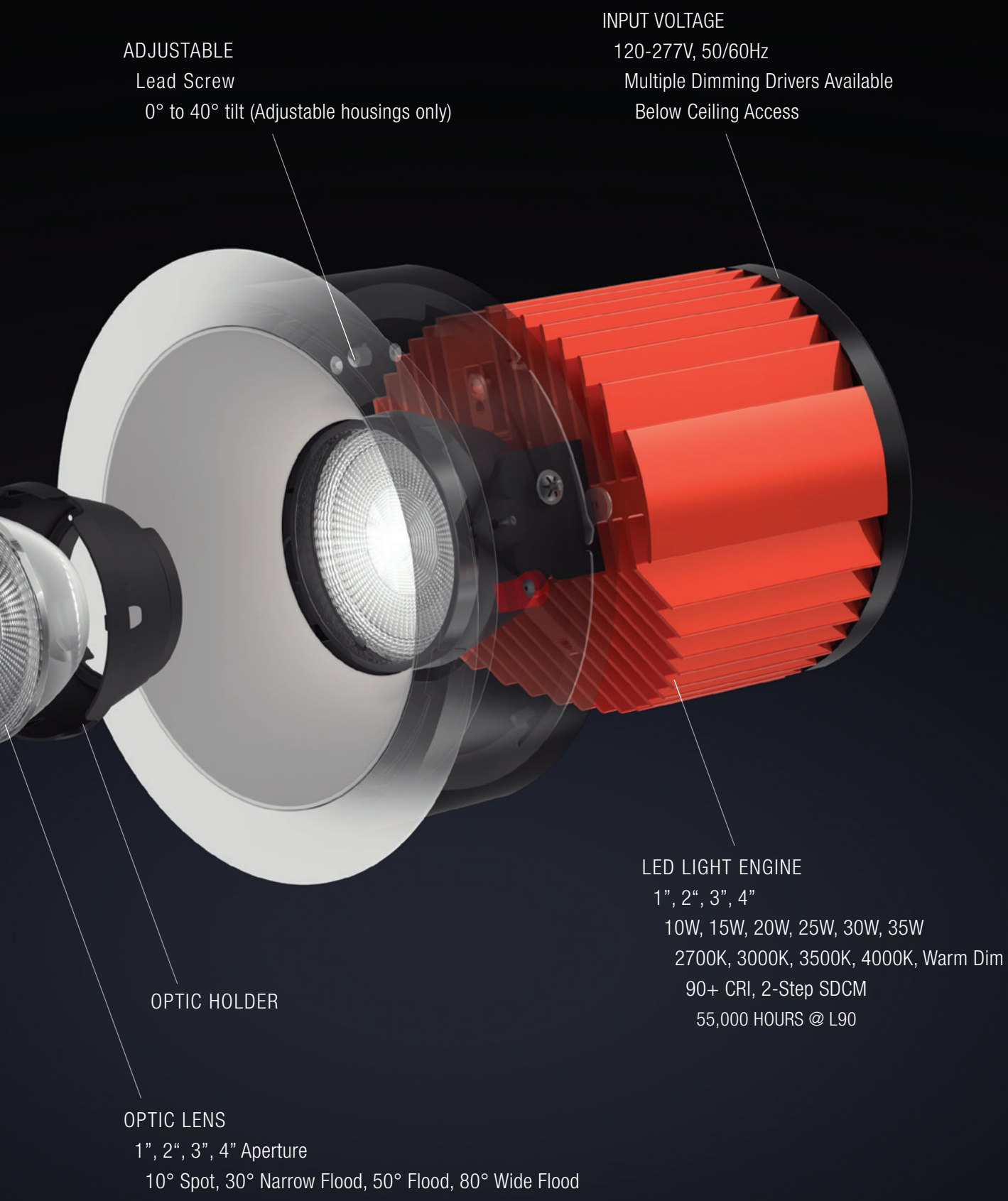

ADJUSTABLE
Lead Screw
0° to 40° tilt (Adjustable housings only)

INPUT VOLTAGE
120-277V, 50/60Hz
Multiple Dimming Drivers Available
Below Ceiling Access

OPTIC HOLDER

OPTIC LENS
1", 2", 3", 4" Aperture
10° Spot, 30° Narrow Flood, 50° Flood, 80° Wide Flood

LED LIGHT ENGINE
1", 2", 3", 4"
10W, 15W, 20W, 25W, 30W, 35W
2700K, 3000K, 3500K, 4000K, Warm Dim
90+ CRI, 2-Step SDCM
55,000 HOURS @ L90

Some models may have limited options available. See specification sheet for details.

HOUSING

NEW CONSTRUCTION, REMODEL

Acrobat's housings are designed and engineered to fit into tight spaces and optimize performance in any type of installation environment and ceiling material.



IC-R

Adjustable New Construction IC Housing - Round

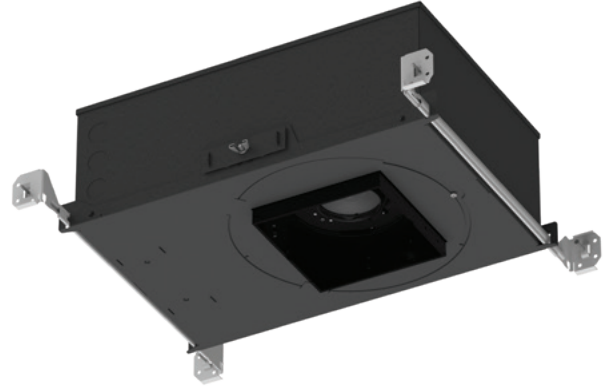

IC-S

Adjustable New Construction IC Housing - Square

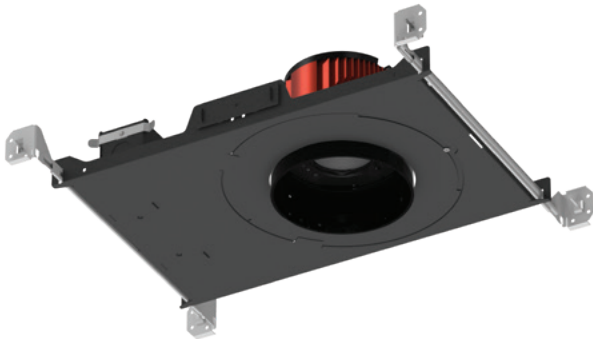

NC-R

Adjustable New Construction Housing - Round

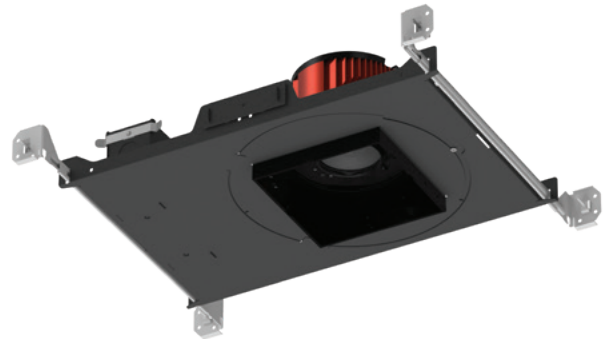

NC-S

Adjustable New Construction Housing - Square

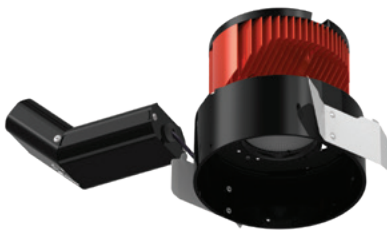

RM-R

Adjustable Remodel Housing - Round

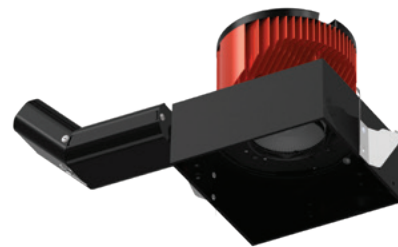

RM-S

Adjustable Remodel Housing - Square

Some models may have limited options available. See specification sheet for details.

HOUSING

SHALLOW PLENUM

Shallow plenum housings adjust to any type of ceiling. They come ready to install into 2½" plenums with IC, Air Tight, and Chicago plenum (CCEA) certifications.

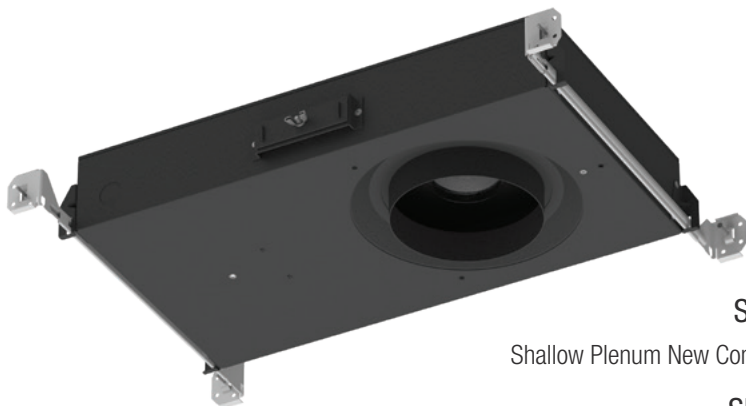
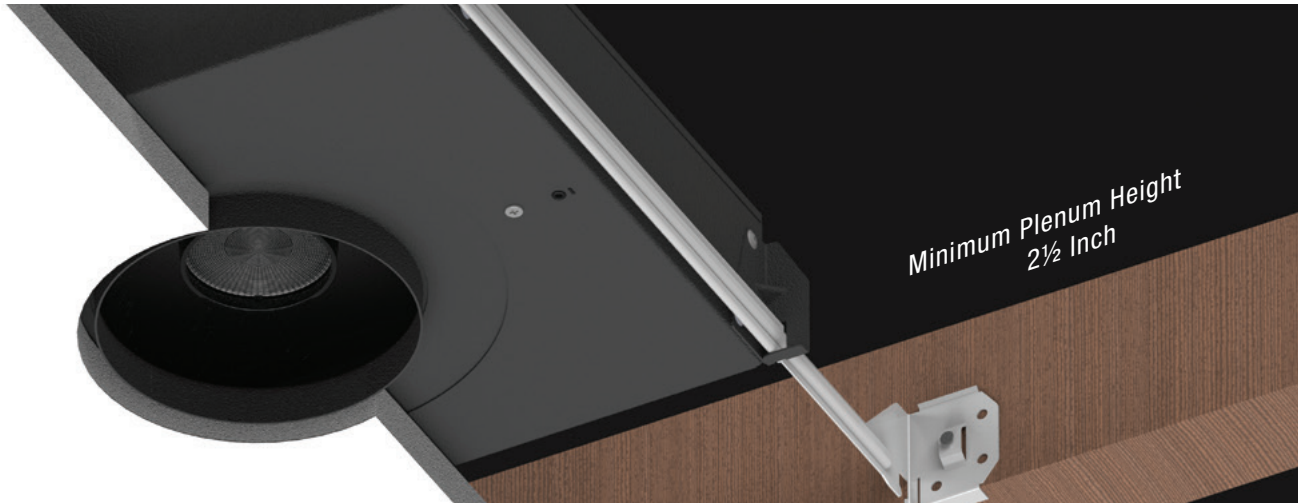

SIC-R

Shallow Plenum New Construction IC Housing - Round

SNC-R

Shallow Plenum New Construction Housing - Round

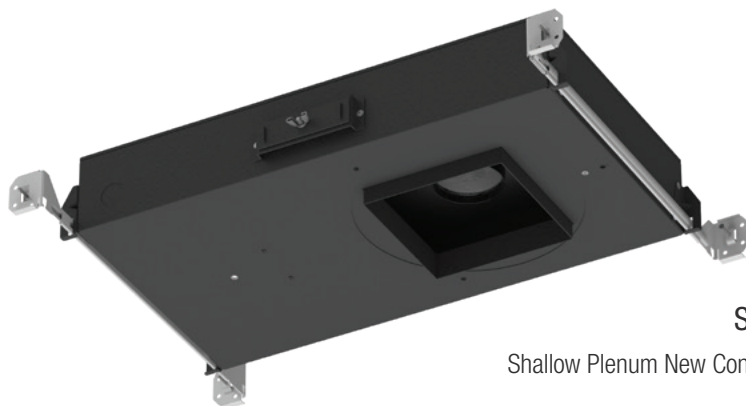

SIC-S

Shallow Plenum New Construction IC Housing - Square

SNC-S

Shallow Plenum New Construction Housing - Square

CEILING THICKNESS

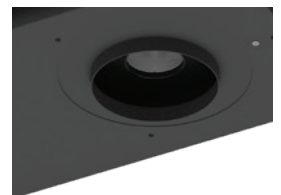

-0

5/8" Ceiling Thickness

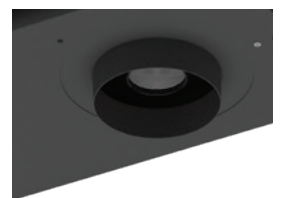

-1

1¼" Ceiling Thickness

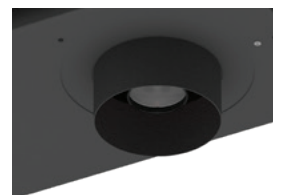

-2

2" Ceiling Thickness

Some models may have limited options available. See specification sheet for details.



Scan code for video

TRIM FINISH



RSTWT-STWT

WT - White Trim
WT - White Reflector

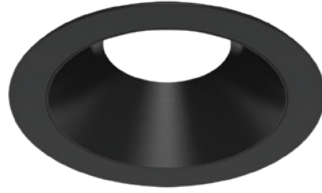

RSTBK-STBK

BK - Black Trim
BK - Black Reflector

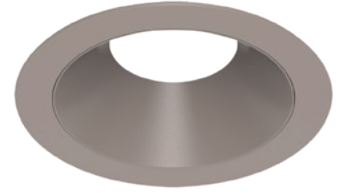

RSTCN-STCN

CN - Champagne Trim
CN - Champagne Reflector

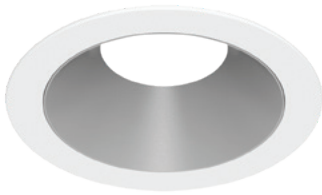

RSTWT-STSA

WT - White Trim
SA - Silver Reflector

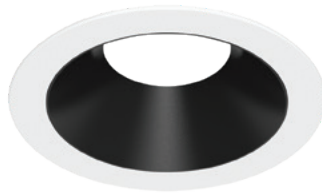

RSTWT-STBK

WT - White Trim
BK - Black Reflector



RSTWT-STCN

WT - White Trim
CN - Champagne Reflector

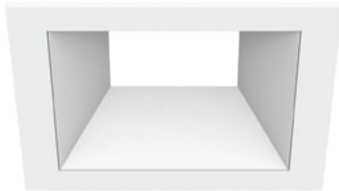

SSTWT-STWT

WT - White Trim
WT - White Reflector



SSTBK-STBK

BK - Black Trim
BK - Black Reflector

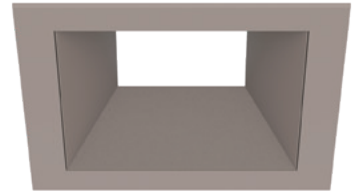

SSTCN-STCN

CN - Champagne Trim
CN - Champagne Reflector

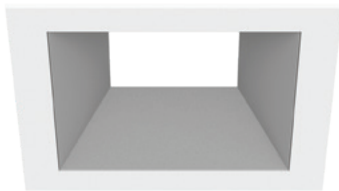

SSTWT-STSA

WT - White Trim
SA - Silver Reflector



SSTWT-STBK

WT - White Trim
BK - Black Reflector

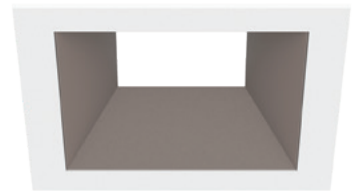

SSTWT-STCN

WT - White Trim
CN - Champagne Reflector

Trim and reflector ship separately to allow for customization. Custom color available only for ST (Standard) Trim.

TRIM STYLE

ROUND



RST
Round Standard Trim
(with Standard Reflector)

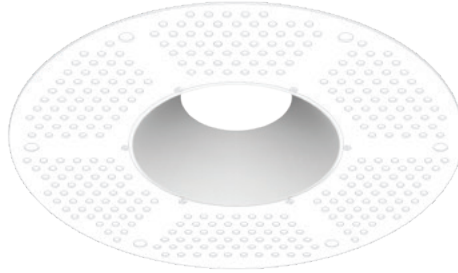

RTL
Round Trimless Mud Plate
(with Standard Reflector)



RWC
Round Wood Ceiling Trim
(with Standard Reflector)

REFLECTOR

ROUND



Trim
RST | Reflector
-ST
Round Standard Trim
with Standard Reflector

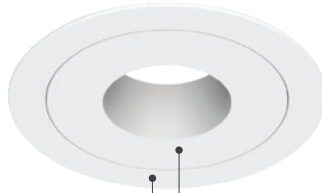

Trim
RST | Reflector
-PH
Round Standard Trim
with Pinhole Reflector



Trim
RST | Reflector
-SP
Round Standard Trim
with Slot Pinhole Reflector



Trim
RST | Reflector
-WW
Round Standard Trim
with Wall Wash Reflector



Trim
RST | Reflector
-AL
Round Standard Trim
with Adjustable Lensed Reflector

Custom color available only for ST (Standard) and AL (Adjustable Lens) Reflectors. Wet Location rated when used with Additional Reflector Lens.

TRIM STYLE SQUARE

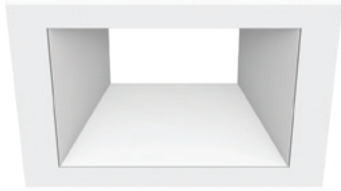

SST
Square Standard Trim
(with Standard Reflector)

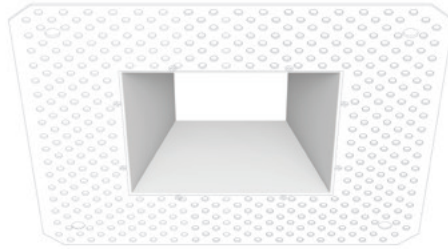

STL
Square Trimless Mud Plate
(with Standard Reflector)

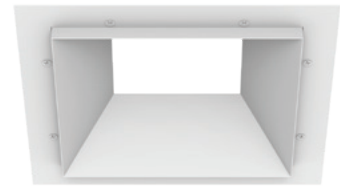

SWC
Square Wood Ceiling Trim
(with Standard Reflector)

REFLECTOR SQUARE

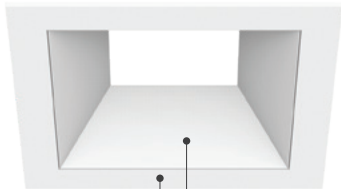

Trim | Reflector
SST | **-ST**
Square Standard Trim
with Standard Reflector

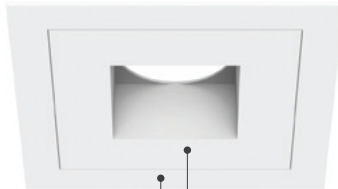

Trim | Reflector
SST | **-PH**
Square Standard Trim
with Pinhole Reflector



Trim | Reflector
SST | **-SP**
Square Standard Trim
with Slot Pinhole Reflector

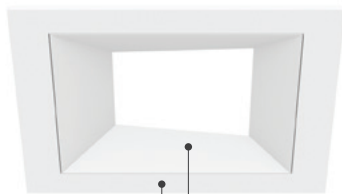

Trim | Reflector
SST | **-WW**
Square Standard Trim
with Wall Wash Reflector

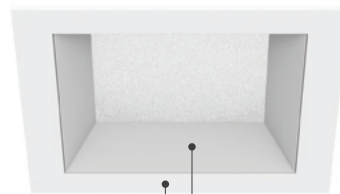

Trim | Reflector
SST | **-AL**
Square Standard Trim
with Adjustable Lensed Reflector

Custom color available only for ST (Standard) and AL (Adjustable Lens) Reflectors. Wet Location rated when used with Additional Reflector Lens.

1" ORDER MATRIX

NEW CONSTRUCTION, REMODEL

1" NEW CONSTRUCTION, REMODEL (EXAMPLE: A1-IC-RST-10S-SHB)

HOUSING BASE				
FAMILY APERTURE	INSTALLATION TYPE		TRIM SHAPE	TRIM STYLE
A1- Acrobat 1"	<input type="checkbox"/> IC (Adjustable New Construction, IC, CCEA) <input type="checkbox"/> NC (Adjustable New Construction) <input type="checkbox"/> RM (Adjustable Remodel)		<input type="checkbox"/> -R (Round) <input type="checkbox"/> -S (Square)	<input type="checkbox"/> ST (Standard) <input type="checkbox"/> TL (Trimless)
DRIVER ASSEMBLY				
WATTAGE	LED DIMMING DRIVER		HANGER BAR	WARM DIM
<input type="checkbox"/> -10 (10 Watt) <input type="checkbox"/> -15¹ (15 Watt)	<input type="checkbox"/> S⁵ (Universal Dim Driver: 1%-100% 0-10V, TRIAC, ELV, 120V/277V) <input type="checkbox"/> L1^{2,3,4} (Lutron Dim Driver: Lutron Dim Driver: 1%-100% TRIAC, 120V) <input type="checkbox"/> L3^{2,3,4} (Lutron Dim Driver: 1%-100% EcoSystem, 120V/277V) <input type="checkbox"/> EL1^{2,3} (EldoLED DALI Dim: 1%-100% DALI, 120V/277V) <input type="checkbox"/> EL2^{2,3} (EldoLED Dim: 0.1%-100% 0-10V, 120V/277V) <input type="checkbox"/> DMX^{2,3} (DMX Dim: 1%-100% DMX, 120V/277V)		<input type="checkbox"/> -SHB (Standard) <input type="checkbox"/> -C24 (24" C-Channel) <input type="checkbox"/> -C48 (48" C-Channel)	<input type="checkbox"/> (blank) (Standard) <input type="checkbox"/> -WD⁶ (Warm Dim)
	REMOTE LED DIMMING DRIVER			
	<input type="checkbox"/> SR1⁵ (Remote Universal Dim: 1%-100% 0-10V, TRIAC, or ELV, 120V/277V) <input type="checkbox"/> LR1⁴ (Lutron Remote Dim Driver: 1%-100% TRIAC, 120V)			

1. 15 Watt option only available for NC (Adjustable New Construction), RM (Adjustable Remodel) housings.

2. Driver access above ceiling only.

3. Driver only available for IC and NC housings.

4. Ambient temperature rated for 25 C.

5. TRIAC, ELV dimming for 120V only.

6. WD CCT must also be selected in Module section.

1" NEW CONSTRUCTION, REMODEL (EXAMPLE: A1-2790-RSTWT-STWTNL-30)

FAMILY APERTURE	LED PERFORMANCE		TRIM		
	CCT	CRI	TRIM SHAPE	TRIM STYLE	TRIM FINISH
A1- Acrobat 1"	<input type="checkbox"/> 27 (2700K) <input type="checkbox"/> 30 (3000K) <input type="checkbox"/> 35 (3500K) <input type="checkbox"/> 40 (4000K) <input type="checkbox"/> WD⁵ (1800K-3000K)	90 (90 CRI)	<input type="checkbox"/> -R (Round) <input type="checkbox"/> -S (Square)	<input type="checkbox"/> ST (Standard) <input type="checkbox"/> TL (Trimless)	<input type="checkbox"/> TL (Trimless) <input type="checkbox"/> WT (White) <input type="checkbox"/> BK (Black) <input type="checkbox"/> CN (Champagne) <input type="checkbox"/> SA (Satin Aluminum) <input type="checkbox"/> CC¹ (Custom Color)
REFLECTOR			OPTIC AND MEDIA		
REFLECTOR STYLE	REFLECTOR FINISH	REFLECTOR LENS	OPTIC	MEDIA 1	MEDIA 2
<input type="checkbox"/> -ST² (Standard) <input type="checkbox"/> -PH (Pinhole) <input type="checkbox"/> -SP (Slot Pinhole) <input type="checkbox"/> -WW (Wall Wash)	<input type="checkbox"/> WT (White) <input type="checkbox"/> BK (Black) <input type="checkbox"/> CA³ (Clear Alzak) <input type="checkbox"/> CN (Champagne) <input type="checkbox"/> SA (Satin Aluminum) <input type="checkbox"/> CC¹ (Custom Color)	<input type="checkbox"/> NL (No Lens) <input type="checkbox"/> CL (Clear) <input type="checkbox"/> MP (Solite) <input type="checkbox"/> FR (Frosted)	<input type="checkbox"/> -10 (10° Spot) <input type="checkbox"/> -30 (30° Narrow Flood) <input type="checkbox"/> -50 (50° Flood) <input type="checkbox"/> -80 (80° Wide Flood)	<input type="checkbox"/> (blank) (None) <input type="checkbox"/> CL (Clear Lens) <input type="checkbox"/> MP (Solite Lens) <input type="checkbox"/> FR (Frosted Lens) <input type="checkbox"/> LS (Linear Spread Lens) <input type="checkbox"/> HX⁴ (Hex Louver)	<input type="checkbox"/> (blank) (None) <input type="checkbox"/> CL (Clear Lens) <input type="checkbox"/> MP (Solite Lens) <input type="checkbox"/> FR (Frosted Lens) <input type="checkbox"/> LS (Linear Spread Lens)

1. Custom color only available for ST (Standard) Trim and ST (Standard) Reflector only, contact CSL for details.

2. Wet Location rated when used with Additional Reflector Lens.

3. CA (Clear Alzak) Finish only available for R (Round), ST (Standard) Reflector.

4. Cannot be used with a second Media.

5. Media 1 lens required. For WD with 10°, 30°, 50° Optic use MP (Solite Lens). For WD with 80° Optic use FR (Frosted Lens).

1" ORDER MATRIX

SHALLOW PLENUM

1" SHALLOW PLENUM NEW CONSTRUCTION (EXAMPLE: A1-SIC-RST-02790-30-10S-SHB)

HOUSING BASE					
FAMILY APERTURE	INSTALLATION TYPE			TRIM SHAPE	TRIM STYLE
A1- Acrobat 1"	<input type="checkbox"/> SIC (Shallow Plenum New Construction, IC, CCEA)			<input type="checkbox"/> -R (Round)	<input type="checkbox"/> ST (Standard)
	<input type="checkbox"/> SNC (Shallow Plenum New Construction)			<input type="checkbox"/> -S (Square)	<input type="checkbox"/> TL (Trimless)
CEILING	LED PERFORMANCE		OPTIC AND MEDIA		
CEILING THICKNESS	CCT	CRI	OPTIC	MEDIA 1	MEDIA 2
<input type="checkbox"/> -0 (5/8" Ceiling Thickness)	<input type="checkbox"/> 27 (2700K)	90 (90 CRI)	<input type="checkbox"/> -10 (10° Spot)	<input type="checkbox"/> (blank) (None)	<input type="checkbox"/> (blank) (None)
<input type="checkbox"/> -1 (1 1/4" Ceiling Thickness)	<input type="checkbox"/> 30 (3000K)		<input type="checkbox"/> -30 (30° Narrow Flood)	<input type="checkbox"/> CL (Clear Lens)	<input type="checkbox"/> CL (Clear Lens)
<input type="checkbox"/> -2 (2" Ceiling Thickness)	<input type="checkbox"/> 35 (3500K)		<input type="checkbox"/> -50 (50° Flood)	<input type="checkbox"/> MP (Solite Lens)	<input type="checkbox"/> MP (Solite Lens)
	<input type="checkbox"/> 40 (4000K)		<input type="checkbox"/> -80 (80° Wide Flood)	<input type="checkbox"/> FR (Frosted Lens)	<input type="checkbox"/> FR (Frosted Lens)
	<input type="checkbox"/> WD³ (1800K~3000K)			<input type="checkbox"/> LS (Linear Spread Lens)	<input type="checkbox"/> LS (Linear Spread Lens)
				<input type="checkbox"/> HX¹ (Hex Louver)	
DRIVER ASSEMBLY					
WATTAGE	LED DIMMING DRIVER		HANGER BAR		
<input type="checkbox"/> -10 (10 Watt)	<input type="checkbox"/> S⁴ (Universal Dim Driver: 1%-100% 0-10V, TRIAC, ELV, 120V/277V)			<input type="checkbox"/> -SHB (Standard)	
<input type="checkbox"/> -15² (15 Watt)		REMOTE LED DIMMING DRIVER		<input type="checkbox"/> -C24 (24" C-Channel)	
		<input type="checkbox"/> SR1⁴ (Remote Universal Dim: 1%-100% 0-10V, TRIAC, or ELV, 120V/277V)		<input type="checkbox"/> -C48 (48" C-Channel)	
	<input type="checkbox"/> LR1 (Lutron Remote Dim Driver: 1%-100% TRIAC, 120V)				

1. Cannot be used with a second media.
2. 15 Watt option only available for SNC (Shallow Plenum New Construction) only.
3. Media 1 lens required. For WD with 10°, 30°, 50° Optic use MP (Solite Lens). For WD with 80° Optic use FR (Frosted Lens).
4. TRIAC, ELV dimming for 120V only.

1" SHALLOW PLENUM NEW CONSTRUCTION (EXAMPLE: A1-RSTWT-STWT-NL)

TRIM				REFLECTOR		
FAMILY APERTURE	TRIM SHAPE	TRIM STYLE	TRIM FINISH	REFLECTOR STYLE	REFLECTOR FINISH	REFLECTOR LENS
A1- Acrobat 1"	<input type="checkbox"/> -R (Round)	<input type="checkbox"/> ST (Standard)	<input type="checkbox"/> TL (Trimless)	<input type="checkbox"/> -ST² (Standard)	<input type="checkbox"/> WT (White)	<input type="checkbox"/> NL (No Lens)
	<input type="checkbox"/> -S (Square)	<input type="checkbox"/> TL (Trimless)	<input type="checkbox"/> WT (White/)	<input type="checkbox"/> -PH (Pinhole)	<input type="checkbox"/> BK (Black)	<input type="checkbox"/> CL (Clear)
			<input type="checkbox"/> BK (Black)	<input type="checkbox"/> -SP (Slot Pinhole)	<input type="checkbox"/> CA³ (Clear Alzak)	<input type="checkbox"/> MP (Solite)
			<input type="checkbox"/> CN (Champagne)	<input type="checkbox"/> -WW (Wall Wash)	<input type="checkbox"/> CN (Champagne)	<input type="checkbox"/> FR (Frosted)
			<input type="checkbox"/> SA (Satin Aluminum)		<input type="checkbox"/> SA (Satin Aluminum)	
			<input type="checkbox"/> CC¹ (Custom Color)		<input type="checkbox"/> CC¹ (Custom Color)	

1. Custom color only available for ST (Standard) Trim and ST (Standard) Reflector only, contact CSL for details.
2. Wet Location rated when used with Additional Reflector Lens.
3. CA (Clear Alzak) Finish only available for R (Round), ST (Standard) Reflector.

2" ORDER MATRIX

NEW CONSTRUCTION, REMODEL

2" NEW CONSTRUCTION, REMODEL (EXAMPLE: A2-IC-RST-10S-SHB)

HOUSING BASE				
FAMILY APERTURE	INSTALLATION TYPE		TRIM SHAPE	TRIM STYLE
A2- Acrobat 2"	<input type="checkbox"/> IC (Adjustable New Construction, IC, CCEA)	<input type="checkbox"/> NC (Adjustable New Construction)	<input type="checkbox"/> -R (Round)	<input type="checkbox"/> ST (Standard)
	<input type="checkbox"/> RM (Adjustable Remodel)		<input type="checkbox"/> -S (Square)	<input type="checkbox"/> TL (Trimless)
				<input type="checkbox"/> WC (Wood Ceiling)
DRIVER ASSEMBLY				
WATTAGE	LED DIMMING DRIVER		HANGER BAR	WARM DIM
<input type="checkbox"/> -10 (10 Watt)	<input type="checkbox"/> S⁵ (Universal Dim Driver: 1%-100% 0-10V, TRIAC, ELV, 120V/277V)		<input type="checkbox"/> -SHB (Standard)	<input type="checkbox"/> (blank) (Standard)
<input type="checkbox"/> -15 (15 Watt)	<input type="checkbox"/> L1^{2,3,4} (Lutron Dim Driver: Lutron Dim Driver: 1%-100% TRIAC, 120V)		<input type="checkbox"/> -C24 (24" C-Channel)	<input type="checkbox"/> -WD⁶ (Warm Dim)
<input type="checkbox"/> -20¹ (20 Watt)	<input type="checkbox"/> L3^{2,3,4} (Lutron Dim Driver: 1%-100% EcoSystem, 120V/277V)		<input type="checkbox"/> -C48 (48" C-Channel)	
	<input type="checkbox"/> EL1^{2,3} (EldoLED DALI Dim: 1%-100% DALI, 120V/277V)			
	<input type="checkbox"/> EL2^{2,3} (EldoLED Dim: 0.1%-100% 0-10V, 120V/277V)			
	<input type="checkbox"/> DMX^{2,3} (DMX Dim: 1%-100% DMX, 120V/277V)			
	REMOTE LED DIMMING DRIVER			
	<input type="checkbox"/> SR1⁵ (Remote Universal Dim: 1%-100% 0-10V, TRIAC, or ELV, 120V/277V)			
	<input type="checkbox"/> LR1⁴ (Lutron Remote Dim Driver: 1%-100% TRIAC, 120V)			

1. 20 Watt option only available for NC (Adjustable New Construction), RM (Adjustable Remodel), SNC (Shallow New Construction) housings.

2. Driver access above ceiling only.

4. Ambient temperature rated for 25 C.

3. Driver only available for IC and NC housings.

5. TRIAC, ELV dimming for 120V only.

6. WD CCT must also be selected in Module section.

2" NEW CONSTRUCTION, REMODEL (EXAMPLE: A2-2790-RSTWT-STWTNL-30)

FAMILY APERTURE	LED PERFORMANCE		TRIM		
	CCT	CRI	TRIM SHAPE	TRIM STYLE	TRIM FINISH
A2- Acrobat 2"	<input type="checkbox"/> 27 (2700K)	90 (90 CRI)	<input type="checkbox"/> -R (Round)	<input type="checkbox"/> ST (Standard)	<input type="checkbox"/> TL⁷ (Trimless/Wood Ceiling)
	<input type="checkbox"/> 30 (3000K)		<input type="checkbox"/> -S (Square)	<input type="checkbox"/> TL (Trimless)	<input type="checkbox"/> WT (White)
	<input type="checkbox"/> 35 (3500K)			<input type="checkbox"/> WC (Wood Ceiling)	<input type="checkbox"/> BK (Black)
	<input type="checkbox"/> 40 (4000K)				<input type="checkbox"/> CN (Champagne)
	<input type="checkbox"/> WD⁶ (1800K-3000K)				<input type="checkbox"/> SA (Satin Aluminum)
					<input type="checkbox"/> CC¹ (Custom Color)
REFLECTOR			OPTIC AND MEDIA		
REFLECTOR STYLE	REFLECTOR FINISH	REFLECTOR LENS	OPTIC	MEDIA 1	MEDIA 2
<input type="checkbox"/> -ST² (Standard)	<input type="checkbox"/> WT (White)	<input type="checkbox"/> NL (No Lens)	<input type="checkbox"/> -10 (10° Spot)	<input type="checkbox"/> (blank) (None)	<input type="checkbox"/> (blank) (None)
<input type="checkbox"/> -PH (Pinhole)	<input type="checkbox"/> BK (Black)	<input type="checkbox"/> CL (Clear)	<input type="checkbox"/> -30 (30° Narrow Flood)	<input type="checkbox"/> CL (Clear Lens)	<input type="checkbox"/> CL (Clear Lens)
<input type="checkbox"/> -SP (Slot Pinhole)	<input type="checkbox"/> CA⁴ (Clear Alzak)	<input type="checkbox"/> MP (Solite)	<input type="checkbox"/> -50 (50° Flood)	<input type="checkbox"/> MP (Solite Lens)	<input type="checkbox"/> MP (Solite Lens)
<input type="checkbox"/> -WW (Wall Wash)	<input type="checkbox"/> CN (Champagne)	<input type="checkbox"/> FR (Frosted)	<input type="checkbox"/> -80 (80° Wide Flood)	<input type="checkbox"/> FR (Frosted Lens)	<input type="checkbox"/> FR (Frosted Lens)
<input type="checkbox"/> -AL^{2,3} (Adjustable Lensed)	<input type="checkbox"/> SA (Satin Aluminum)			<input type="checkbox"/> LS (Linear Spread Lens)	<input type="checkbox"/> LS (Linear Spread Lens)
	<input type="checkbox"/> CC¹ (Custom Color)			<input type="checkbox"/> HX⁵ (Hex Louver)	

1. Custom color only available for ST (Standard) Trim and ST (Standard), AL (Adjustable Lens) Reflectors only, contact CSL for details.

2. Wet Location rated when used with Additional Reflector Lens.

3. Must be ordered with corresponding Additional Reflector Lens.

4. CA (Clear Alzak) Finish only available for Round reflectors as ST (Standard) or AL (Adjustable Lens) styles.

5. Cannot be used with a second Media.

6. Media 1 lens required. For WD with 10°, 30°, 50° Optic use MP (Solite Lens).
For WD with 80° Optic use FR (Frosted Lens).

7. Must be used with TL or WC trim style.

2" ORDER MATRIX

SHALLOW PLENUM

2" SHALLOW PLENUM NEW CONSTRUCTION (EXAMPLE: A2-SIC-RST-02790-30-10S-SHB)

HOUSING BASE					
FAMILY APERTURE	INSTALLATION TYPE			TRIM SHAPE	TRIM STYLE
A2- Acrobat 2"	<input type="checkbox"/> SIC (Shallow Plenum New Construction, IC, CCEA)			<input type="checkbox"/> -R (Round)	<input type="checkbox"/> ST (Standard)
	<input type="checkbox"/> SNC (Shallow Plenum New Construction)			<input type="checkbox"/> -S (Square)	<input type="checkbox"/> TL (Trimless) <input type="checkbox"/> WC (Wood Ceiling)
CEILING	LED PERFORMANCE		OPTIC AND MEDIA		
CEILING THICKNESS	CCT	CRI	OPTIC	MEDIA 1	MEDIA 2
<input type="checkbox"/> -0 (5/8" Ceiling Thickness)	<input type="checkbox"/> 27 (2700K)	90 (90 CRI)	<input type="checkbox"/> -10 (10° Spot)	<input type="checkbox"/> (blank) (None)	<input type="checkbox"/> (blank) (None)
<input type="checkbox"/> -1 (1 1/4" Ceiling Thickness)	<input type="checkbox"/> 30 (3000K)		<input type="checkbox"/> -30 (30° Narrow Flood)	<input type="checkbox"/> CL (Clear Lens)	<input type="checkbox"/> CL (Clear Lens)
<input type="checkbox"/> -2 (2" Ceiling Thickness)	<input type="checkbox"/> 35 (3500K)		<input type="checkbox"/> -50 (50° Flood)	<input type="checkbox"/> MP (Solite Lens)	<input type="checkbox"/> MP (Solite Lens)
	<input type="checkbox"/> 40 (4000K)		<input type="checkbox"/> -80 (80° Wide Flood)	<input type="checkbox"/> FR (Frosted Lens)	<input type="checkbox"/> FR (Frosted Lens)
	<input type="checkbox"/> WD ³ (1800K~3000K)			<input type="checkbox"/> LS (Linear Spread Lens)	<input type="checkbox"/> LS (Linear Spread Lens)
			<input type="checkbox"/> HX ¹ (Hex Louver)		
DRIVER ASSEMBLY					
WATTAGE	LED DIMMING DRIVER		HANGER BAR		
<input type="checkbox"/> -10 (10 Watt)	<input type="checkbox"/> S ⁴ (Universal Dim Driver: 1%-100% 0-10V, TRIAC, ELV, 120V/277V)		<input type="checkbox"/> -SHB (Standard)		
<input type="checkbox"/> -15 (15 Watt)	<input type="checkbox"/> SR1 ⁴ (Remote Universal Dim: 1%-100% 0-10V, TRIAC, or ELV, 120V/277V)		<input type="checkbox"/> -C24 (24" C-Channel)		
<input type="checkbox"/> -20 ² (20 Watt)			<input type="checkbox"/> -C48 (48" C-Channel)		
	<input type="checkbox"/> LR1 (Lutron Remote Dim Driver: 1%-100% TRIAC, 120V)				

1. Cannot be used with a second media.
2. 20 Watt option only available for SNC (Shallow Plenum New Construction) only.
3. Media 1 lens required. For WD with 10°, 30°, 50° Optic use MP (Solite Lens). For WD with 80° Optic use FR (Frosted Lens).
4. TRIAC, ELV dimming for 120V only.

2" SHALLOW PLENUM NEW CONSTRUCTION (EXAMPLE: A2-RSTWT-STWT-NL)

TRIM				REFLECTOR		
FAMILY APERTURE	TRIM SHAPE	TRIM STYLE	TRIM FINISH	REFLECTOR STYLE	REFLECTOR FINISH	REFLECTOR LENS
A2- Acrobat 2"	<input type="checkbox"/> -R (Round)	<input type="checkbox"/> ST (Standard)	<input type="checkbox"/> TL ⁵ (Trimless/Wood Ceiling)	<input type="checkbox"/> -ST ² (Standard)	<input type="checkbox"/> WT (White)	<input type="checkbox"/> NL (No Lens)
	<input type="checkbox"/> -S (Square)	<input type="checkbox"/> TL (Trimless)	<input type="checkbox"/> WT (White/)	<input type="checkbox"/> -PH (Pinhole)	<input type="checkbox"/> BK (Black)	<input type="checkbox"/> CL (Clear)
		<input type="checkbox"/> WC (Wood Ceiling)	<input type="checkbox"/> BK (Black)	<input type="checkbox"/> -SP (Slot Pinhole)	<input type="checkbox"/> CA ⁴ (Clear Alzak)	<input type="checkbox"/> MP (Solite)
			<input type="checkbox"/> CN (Champagne)	<input type="checkbox"/> -WW (Wall Wash)	<input type="checkbox"/> CN (Champagne)	<input type="checkbox"/> FR (Frosted)
			<input type="checkbox"/> SA (Satin Aluminum)	<input type="checkbox"/> -AL ^{2,3} (Adjustable Lensed)	<input type="checkbox"/> SA (Satin Aluminum)	
			<input type="checkbox"/> CC ¹ (Custom Color)		<input type="checkbox"/> CC ¹ (Custom Color)	

1. Custom color only available for ST (Standard) Trim and ST (Standard), AL (Adjustable Lens) Reflectors only, contact CSL for details.
2. Wet Location rated when used with Additional Reflector Lens.
3. Must be ordered with corresponding Additional Reflector Lens.
4. CA (Clear Alzak) Finish only available for Round reflectors as ST (Standard) or AL (Adjustable Lens) styles.
5. Must be used with TL or WC trim style.

3" ORDER MATRIX

NEW CONSTRUCTION, REMODEL

3" NEW CONSTRUCTION, REMODEL (EXAMPLE: A3-IC-RST-10S-SHB)

HOUSING BASE				
FAMILY APERTURE	INSTALLATION TYPE		TRIM SHAPE	TRIM STYLE
A3- Acrobat 3"	<input type="checkbox"/> IC (Adjustable New Construction, IC, CCEA)	<input type="checkbox"/> NC (Adjustable New Construction)	<input type="checkbox"/> -R (Round)	<input type="checkbox"/> ST (Standard)
	<input type="checkbox"/> RM (Adjustable Remodel)		<input type="checkbox"/> -S (Square)	<input type="checkbox"/> TL (Trimless)
				<input type="checkbox"/> WC (Wood Ceiling)
DRIVER ASSEMBLY				
WATTAGE	LED DIMMING DRIVER		HANGER BAR	WARM DIM
<input type="checkbox"/> -10 (10 Watt)	<input type="checkbox"/> S³ (Universal Dim Driver: 1%-100% 0-10V, TRIAC, ELV, 120V/277V)		<input type="checkbox"/> -SHB (Standard)	<input type="checkbox"/> (blank) (Standard)
<input type="checkbox"/> -15 (15 Watt)	<input type="checkbox"/> L1² (Lutron Dim Driver: Lutron Dim Driver: 1%-100% TRIAC, 120V)		<input type="checkbox"/> -C24 (24" C-Channel)	<input type="checkbox"/> -WD⁴ (Warm Dim)
<input type="checkbox"/> -20 (20 Watt)	<input type="checkbox"/> L3² (Lutron Dim Driver: 1%-100% EcoSystem, 120V/277V)		<input type="checkbox"/> -C48 (48" C-Channel)	
<input type="checkbox"/> -25¹ (25 Watt)	<input type="checkbox"/> EL1 (EldoLED DALI Dim: 1%-100% DALI, 120V/277V)			
	<input type="checkbox"/> EL2 (EldoLED Dim: 0.1%-100% 0-10V, 120V/277V)			
	<input type="checkbox"/> DMX (DMX Dim: 1%-100% DMX, 120V/277V)			
	REMOTE LED DIMMING DRIVER			
	<input type="checkbox"/> SR1³ (Remote Universal Dim: 1%-100% 0-10V, TRIAC, or ELV, 120V/277V)			
	<input type="checkbox"/> LR1² (Lutron Remote Dim Driver: 1%-100% TRIAC, 120V)			

1. 25 Watt option only available for NC (Adjustable New Construction), RM (Adjustable Remodel), SNC (Shallow New Construction) housings.

2. Ambient temperature rated for 25 C.

3. TRIAC, ELV dimming for 120V only.

4. WD CCT must also be selected in Module section.

3" NEW CONSTRUCTION, REMODEL (EXAMPLE: A3-2790-RSTWT-STWTNL-30)

FAMILY APERTURE	LED PERFORMANCE		TRIM		
	CCT	CRI	TRIM SHAPE	TRIM STYLE	TRIM FINISH
A3- Acrobat 3"	<input type="checkbox"/> 27 (2700K)	90 (90 CRI)	<input type="checkbox"/> -R (Round)	<input type="checkbox"/> ST (Standard)	<input type="checkbox"/> TL⁷ (Trimless/Wood Ceiling)
	<input type="checkbox"/> 30 (3000K)		<input type="checkbox"/> -S (Square)	<input type="checkbox"/> TL (Trimless)	<input type="checkbox"/> WT (White/)
	<input type="checkbox"/> 35 (3500K)			<input type="checkbox"/> WC (Wood Ceiling)	<input type="checkbox"/> BK (Black)
	<input type="checkbox"/> 40 (4000K)				<input type="checkbox"/> CN (Champagne)
	<input type="checkbox"/> WD⁶ (1800K-3000K)				<input type="checkbox"/> SA (Satin Aluminum)
					<input type="checkbox"/> CC¹ (Custom Color)
REFLECTOR			OPTIC AND MEDIA		
REFLECTOR STYLE	REFLECTOR FINISH	REFLECTOR LENS	OPTIC	MEDIA 1	MEDIA 2
<input type="checkbox"/> -ST² (Standard)	<input type="checkbox"/> WT (White)	<input type="checkbox"/> NL (No Lens)	<input type="checkbox"/> -10 (10° Spot)	<input type="checkbox"/> (blank) (None)	<input type="checkbox"/> (blank) (None)
<input type="checkbox"/> -PH (Pinhole)	<input type="checkbox"/> BK (Black)	<input type="checkbox"/> CL (Clear)	<input type="checkbox"/> -30 (30° Narrow Flood)	<input type="checkbox"/> CL (Clear Lens)	<input type="checkbox"/> CL (Clear Lens)
<input type="checkbox"/> -SP (Slot Pinhole)	<input type="checkbox"/> CA⁴ (Clear Alzak)	<input type="checkbox"/> MP (Solite)	<input type="checkbox"/> -50 (50° Flood)	<input type="checkbox"/> MP (Solite Lens)	<input type="checkbox"/> MP (Solite Lens)
<input type="checkbox"/> -WW (Wall Wash)	<input type="checkbox"/> CN (Champagne)	<input type="checkbox"/> FR (Frosted)	<input type="checkbox"/> -80 (80° Wide Flood)	<input type="checkbox"/> FR (Frosted Lens)	<input type="checkbox"/> FR (Frosted Lens)
<input type="checkbox"/> -AL^{2,3} (Adjustable Lensed)	<input type="checkbox"/> SA (Satin Aluminum)			<input type="checkbox"/> LS (Linear Spread Lens)	<input type="checkbox"/> LS (Linear Spread Lens)
	<input type="checkbox"/> CC¹ (Custom Color)			<input type="checkbox"/> HX⁵ (Hex Louver)	

1. Custom color only available for ST (Standard) Trim and ST (Standard), AL (Adjustable Lens) Reflectors only, contact CSL for details.

2. Wet Location rated when used with Additional Reflector Lens.

3. Must be ordered with corresponding Additional Reflector Lens.

4. CA (Clear Alzak) Finish only available for Round reflectors as ST (Standard) or AL (Adjustable Lens) styles.

5. Cannot be used with a second Media.

6. Media 1 lens required. For WD with 10°, 30°, 50° Optic use MP (Solite Lens).
For WD with 80° Optic use FR (Frosted Lens).

7. Must be used with TL or WC trim style.

3" ORDER MATRIX

SHALLOW PLENUM

3" SHALLOW PLENUM NEW CONSTRUCTION (EXAMPLE: A3-SIC-RST-02790-30-10S-SHB)

HOUSING BASE					
FAMILY APERTURE	INSTALLATION TYPE			TRIM SHAPE	TRIM STYLE
A3- Acrobat 3"	<input type="checkbox"/> SIC (Shallow Plenum New Construction, IC, CCEA)			<input type="checkbox"/> -R (Round)	<input type="checkbox"/> ST (Standard)
	<input type="checkbox"/> SNC (Shallow Plenum New Construction)			<input type="checkbox"/> -S (Square)	<input type="checkbox"/> TL (Trimless) <input type="checkbox"/> WC (Wood Ceiling)
CEILING	LED PERFORMANCE		OPTIC AND MEDIA		
CEILING THICKNESS	CCT	CRI	OPTIC	MEDIA 1	MEDIA 2
<input type="checkbox"/> -0 (5/8" Ceiling Thickness)	<input type="checkbox"/> 27 (2700K)	90 (90 CRI)	<input type="checkbox"/> -10 (10° Spot)	<input type="checkbox"/> (blank) (None)	<input type="checkbox"/> (blank) (None)
<input type="checkbox"/> -1 (1 1/4" Ceiling Thickness)	<input type="checkbox"/> 30 (3000K)		<input type="checkbox"/> -30 (30° Narrow Flood)	<input type="checkbox"/> CL (Clear Lens)	<input type="checkbox"/> CL (Clear Lens)
<input type="checkbox"/> -2 (2" Ceiling Thickness)	<input type="checkbox"/> 35 (3500K)		<input type="checkbox"/> -50 (50° Flood)	<input type="checkbox"/> MP (Solite Lens)	<input type="checkbox"/> MP (Solite Lens)
	<input type="checkbox"/> 40 (4000K)		<input type="checkbox"/> -80 (80° Wide Flood)	<input type="checkbox"/> FR (Frosted Lens)	<input type="checkbox"/> FR (Frosted Lens)
	<input type="checkbox"/> WD³ (1800K~3000K)			<input type="checkbox"/> LS (Linear Spread Lens)	<input type="checkbox"/> LS (Linear Spread Lens)
				<input type="checkbox"/> HX¹ (Hex Louver)	
DRIVER ASSEMBLY					
WATTAGE	LED DIMMING DRIVER			HANGER BAR	
<input type="checkbox"/> -10 (10 Watt)	<input type="checkbox"/> S⁵ (Universal Dim Driver: 1%-100% 0-10V, TRIAC, ELV, 120V/277V)			<input type="checkbox"/> -SHB (Standard)	
<input type="checkbox"/> -15 (15 Watt)	<input type="checkbox"/> L1⁴ (Lutron Dim Driver: Lutron Dim Driver: 1%-100% TRIAC, 120V)			<input type="checkbox"/> -C24 (24" C-Channel)	
<input type="checkbox"/> -20 (20 Watt)	<input type="checkbox"/> L3⁴ (Lutron Dim Driver: 1%-100% EcoSystem, 120V/277V)			<input type="checkbox"/> -C48 (48" C-Channel)	
<input type="checkbox"/> -25² (25 Watt)	<input type="checkbox"/> EL1 (EldoLED DALI Dim: 1%-100% DALI, 120V/277V)				
	<input type="checkbox"/> EL2 (EldoLED Dim: 0.1%-100% 0-10V, 120V/277V)				
	<input type="checkbox"/> DMX (DMX Dim: 1%-100% DMX, 120V/277V)				
	REMOTE LED DIMMING DRIVER				
	<input type="checkbox"/> SR1⁵ (Remote Universal Dim: 1%-100% 0-10V, TRIAC, or ELV, 120V/277V)				
	<input type="checkbox"/> LR1 (Lutron Remote Dim Driver: 1%-100% TRIAC, 120V)				

1. Cannot be used with a second media.

2. 25 Watt option is only available for SNC configurations.

3. Media 1 lens required. For WD with 10°, 30°, 50° Optic use MP (Solite Lens). For WD with 80° Optic use FR (Frosted Lens).

4. Ambient temperature rated for 25 C.

5. TRIAC, ELV dimming for 120V only.

3" SHALLOW PLENUM NEW CONSTRUCTION (EXAMPLE: A3-RSTWT-STWT-NL)

TRIM				REFLECTOR		
FAMILY APERTURE	TRIM SHAPE	TRIM STYLE	TRIM FINISH	REFLECTOR STYLE	REFLECTOR FINISH	REFLECTOR LENS
A3- Acrobat 3"	<input type="checkbox"/> -R (Round)	<input type="checkbox"/> ST (Standard)	<input type="checkbox"/> TL⁵ (Trimless/Wood Ceiling)	<input type="checkbox"/> -ST² (Standard)	<input type="checkbox"/> WT (White)	<input type="checkbox"/> NL (No Lens)
	<input type="checkbox"/> -S (Square)	<input type="checkbox"/> TL (Trimless) <input type="checkbox"/> WC (Wood Ceiling)	<input type="checkbox"/> WT (White/) <input type="checkbox"/> BK (Black) <input type="checkbox"/> CN (Champagne) <input type="checkbox"/> SA (Satin Aluminum) <input type="checkbox"/> CC¹ (Custom Color)	<input type="checkbox"/> -PH (Pinhole) <input type="checkbox"/> -SP (Slot Pinhole) <input type="checkbox"/> -WW (Wall Wash) <input type="checkbox"/> -AL^{2,3} (Adjustable Lensed)	<input type="checkbox"/> BK (Black) <input type="checkbox"/> CA⁴ (Clear Alzak) <input type="checkbox"/> CN (Champagne) <input type="checkbox"/> SA (Satin Aluminum) <input type="checkbox"/> CC¹ (Custom Color)	<input type="checkbox"/> CL (Clear) <input type="checkbox"/> MP (Solite) <input type="checkbox"/> FR (Frosted)

1. Custom color only available for ST (Standard) Trim and ST (Standard), AL (Adjustable Lens) Reflectors only, contact CSL for details.

2. Wet Location rated when used with Additional Reflector Lens.

3. Must be ordered with corresponding Additional Reflector Lens.

4. CA (Clear Alzak) Finish only available for Round reflectors as ST (Standard) or AL (Adjustable Lens) styles.

5. Must be used with TL or WC trim style.

4" ORDER MATRIX

NEW CONSTRUCTION, REMODEL

4" NEW CONSTRUCTION, REMODEL (EXAMPLE: A4-IC-RST-10S-SHB)

HOUSING BASE				
FAMILY APERTURE	INSTALLATION TYPE		TRIM SHAPE	TRIM STYLE
A4- Acrobat 4"	<input type="checkbox"/> IC (Adjustable New Construction, IC, CCEA)	<input type="checkbox"/> NC (Adjustable New Construction)	<input type="checkbox"/> -R (Round)	<input type="checkbox"/> ST (Standard)
	<input type="checkbox"/> RM (Adjustable Remodel)		<input type="checkbox"/> -S (Square)	<input type="checkbox"/> TL (Trimless)
				<input type="checkbox"/> WC (Wood Ceiling)
DRIVER ASSEMBLY				
WATTAGE	LED DIMMING DRIVER		HANGER BAR	WARM DIM
<input type="checkbox"/> -10 (10 Watt)	<input type="checkbox"/> S³ (Universal Dim Driver: 1%-100% 0-10V, TRIAC, ELV, 120V/277V)		<input type="checkbox"/> -SHB (Standard)	<input type="checkbox"/> (blank) (Standard)
<input type="checkbox"/> -15 (15 Watt)	<input type="checkbox"/> L1² (Lutron Dim Driver: Lutron Dim Driver: 1%-100% TRIAC, 120V)		<input type="checkbox"/> -C24 (24" C-Channel)	<input type="checkbox"/> -WD⁴ (Warm Dim)
<input type="checkbox"/> -20 (20 Watt)	<input type="checkbox"/> L3² (Lutron Dim Driver: 1%-100% EcoSystem, 120V/277V)		<input type="checkbox"/> -C48 (48" C-Channel)	
<input type="checkbox"/> -25 (25 Watt)	<input type="checkbox"/> EL1 (EldoLED DALI Dim: 1%-100% DALI, 120V/277V)			
<input type="checkbox"/> -30¹ (30 Watt)	<input type="checkbox"/> EL2 (EldoLED Dim: 0.1%-100% 0-10V, 120V/277V)			
<input type="checkbox"/> -35¹ (35 Watt)	<input type="checkbox"/> DMX (DMX Dim: 1%-100% DMX, 120V/277V)			
	REMOTE LED DIMMING DRIVER			
	<input type="checkbox"/> SR1³ (Remote Universal Dim: 1%-100% 0-10V, TRIAC, or ELV, 120V/277V)			
	<input type="checkbox"/> LR1² (Lutron Remote Dim Driver: 1%-100% TRIAC, 120V)			

- 30 and 35 Watt options only available for NC (Adjustable New Construction), RM (Adjustable Remodel), SNC (Shallow New Construction) housings.
- Ambient temperature rated for 25 C.
- TRIAC, ELV dimming for 120V only.

- WD CCT must also be selected in Module section.

4" NEW CONSTRUCTION, REMODEL (EXAMPLE: A4-2790-RSTWT-STWTNL-30)

FAMILY APERTURE	LED PERFORMANCE		TRIM		
	CCT	CRI	TRIM SHAPE	TRIM STYLE	TRIM FINISH
A4- Acrobat 4"	<input type="checkbox"/> 27 (2700K)	90 (90 CRI)	<input type="checkbox"/> -R (Round)	<input type="checkbox"/> ST (Standard)	<input type="checkbox"/> TL⁷ (Trimless/Wood Ceiling)
	<input type="checkbox"/> 30 (3000K)		<input type="checkbox"/> -S (Square)	<input type="checkbox"/> TL (Trimless)	<input type="checkbox"/> WT (White/)
	<input type="checkbox"/> 35 (3500K)			<input type="checkbox"/> WC (Wood Ceiling)	<input type="checkbox"/> BK (Black)
	<input type="checkbox"/> 40 (4000K)				<input type="checkbox"/> CN (Champagne)
	<input type="checkbox"/> WD⁶ (1800K~3000K)				<input type="checkbox"/> SA (Satin Aluminum)
					<input type="checkbox"/> CC¹ (Custom Color)
REFLECTOR			OPTIC AND MEDIA		
REFLECTOR STYLE	REFLECTOR FINISH	REFLECTOR LENS	OPTIC	MEDIA 1	MEDIA 2
<input type="checkbox"/> -ST² (Standard)	<input type="checkbox"/> WT (White)	<input type="checkbox"/> NL (No Lens)	<input type="checkbox"/> -10 (10° Spot)	<input type="checkbox"/> (blank) (None)	<input type="checkbox"/> (blank) (None)
<input type="checkbox"/> -PH (Pinhole)	<input type="checkbox"/> BK (Black)	<input type="checkbox"/> CL (Clear)	<input type="checkbox"/> -30 (30° Narrow Flood)	<input type="checkbox"/> CL (Clear Lens)	<input type="checkbox"/> CL (Clear Lens)
<input type="checkbox"/> -SP (Slot Pinhole)	<input type="checkbox"/> CA⁴ (Clear Alzak)	<input type="checkbox"/> MP (Solite)	<input type="checkbox"/> -50 (50° Flood)	<input type="checkbox"/> MP (Solite Lens)	<input type="checkbox"/> MP (Solite Lens)
<input type="checkbox"/> -WW (Wall Wash)	<input type="checkbox"/> CN (Champagne)	<input type="checkbox"/> FR (Frosted)	<input type="checkbox"/> -80 (80° Wide Flood)	<input type="checkbox"/> FR (Frosted Lens)	<input type="checkbox"/> FR (Frosted Lens)
<input type="checkbox"/> -AL^{2,3} (Adjustable Lensed)	<input type="checkbox"/> SA (Satin Aluminum)			<input type="checkbox"/> LS (Linear Spread Lens)	<input type="checkbox"/> LS (Linear Spread Lens)
	<input type="checkbox"/> CC¹ (Custom Color)			<input type="checkbox"/> HX⁵ (Hex Louver)	

- Custom color only available for ST (Standard) Trim and ST (Standard), AL (Adjustable Lens) Reflectors only, contact CSL for details.
- Wet Location rated when used with Additional Reflector Lens.
- Must be ordered with corresponding Additional Reflector Lens.
- CA (Clear Alzak) Finish only available for Round reflectors as ST (Standard) or AL (Adjustable Lens) styles.

- Cannot be used with a second Media.
- Media 1 lens required. For WD with 10°, 30°, 50° Optic use MP (Solite Lens). For WD with 80° Optic use FR (Frosted Lens).
- Must be used with TL or WC trim style.

4" ORDER MATRIX

SHALLOW PLENUM

4" SHALLOW PLENUM NEW CONSTRUCTION (EXAMPLE: A4-SIC-RST-02790-30-10S-SHB)

HOUSING BASE					
FAMILY APERTURE	INSTALLATION TYPE			TRIM SHAPE	TRIM STYLE
A4- Acrobat 4"	<input type="checkbox"/> SIC (Shallow Plenum New Construction, IC, CCEA)			<input type="checkbox"/> -R (Round)	<input type="checkbox"/> ST (Standard)
	<input type="checkbox"/> SNC (Shallow Plenum New Construction)			<input type="checkbox"/> -S (Square)	<input type="checkbox"/> TL (Trimless) <input type="checkbox"/> WC (Wood Ceiling)
CEILING	LED PERFORMANCE		OPTIC AND MEDIA		
CEILING THICKNESS	CCT	CRI	OPTIC	MEDIA 1	MEDIA 2
<input type="checkbox"/> -0 (5/8" Ceiling Thickness)	<input type="checkbox"/> 27 (2700K)	90 (90 CRI)	<input type="checkbox"/> -10 (10° Spot)	<input type="checkbox"/> (blank) (None)	<input type="checkbox"/> (blank) (None)
<input type="checkbox"/> -1 (1 1/4" Ceiling Thickness)	<input type="checkbox"/> 30 (3000K)		<input type="checkbox"/> -30 (30° Narrow Flood)	<input type="checkbox"/> CL (Clear Lens)	<input type="checkbox"/> CL (Clear Lens)
<input type="checkbox"/> -2 (2" Ceiling Thickness)	<input type="checkbox"/> 35 (3500K)		<input type="checkbox"/> -50 (50° Flood)	<input type="checkbox"/> MP (Solite Lens)	<input type="checkbox"/> MP (Solite Lens)
	<input type="checkbox"/> 40 (4000K)		<input type="checkbox"/> -80 (80° Wide Flood)	<input type="checkbox"/> FR (Frosted Lens)	<input type="checkbox"/> FR (Frosted Lens)
	<input type="checkbox"/> WD² (1800K~3000K)			<input type="checkbox"/> LS (Linear Spread Lens)	<input type="checkbox"/> LS (Linear Spread Lens)
			<input type="checkbox"/> HX¹ (Hex Louver)		
DRIVER ASSEMBLY					
WATTAGE	LED DIMMING DRIVER			HANGER BAR	
<input type="checkbox"/> -10 (10 Watt) <input type="checkbox"/> -15 (15 Watt) <input type="checkbox"/> -20 (20 Watt) <input type="checkbox"/> -25 (25 Watt) <input type="checkbox"/> -30¹ (30 Watt) <input type="checkbox"/> -35¹ (35 Watt)	<input type="checkbox"/> S⁴ (Universal Dim Driver: 1%-100% 0-10V, TRIAC, ELV, 120V/277V)			<input type="checkbox"/> -SHB (Standard) <input type="checkbox"/> -C24 (24" C-Channel) <input type="checkbox"/> -C48 (48" C-Channel)	
	<input type="checkbox"/> L1³ (Lutron Dim Driver: Lutron Dim Driver: 1%-100% TRIAC, 120V)				
	<input type="checkbox"/> L3³ (Lutron Dim Driver: 1%-100% EcoSystem, 120V/277V)				
	<input type="checkbox"/> EL1 (EldoLED DALI Dim: 1%-100% DALI, 120V/277V)				
	<input type="checkbox"/> EL2 (EldoLED Dim: 0.1%-100% 0-10V, 120V/277V)				
	<input type="checkbox"/> DMX (DMX Dim: 1%-100% DMX, 120V/277V)				
	REMOTE LED DIMMING DRIVER				
	<input type="checkbox"/> SR1⁴ (Remote Universal Dim: 1%-100% 0-10V, TRIAC, or ELV, 120V/277V)				
	<input type="checkbox"/> LR1³ (Lutron Remote Dim Driver: 1%-100% TRIAC, 120V)				

1. 30 Watt and 35 Watt options only available for SNC (Shallow Plenum New Construction).
2. Media 1 lens required. For WD with 10°, 30°, 50° Optic use MP (Solite Lens). For WD with 80° Optic use FR (Frosted Lens).
3. Ambient temperature rated for 25 C.
4. TRIAC, ELV dimming for 120V only.

4" SHALLOW PLENUM NEW CONSTRUCTION (EXAMPLE: A3-RSTWT-STWT-NL)

TRIM				REFLECTOR		
FAMILY APERTURE	TRIM SHAPE	TRIM STYLE	TRIM FINISH	REFLECTOR STYLE	REFLECTOR FINISH	REFLECTOR LENS
A4- Acrobat 4"	<input type="checkbox"/> -R (Round)	<input type="checkbox"/> ST (Standard)	<input type="checkbox"/> TL⁵ (Trimless/Wood Ceiling)	<input type="checkbox"/> -ST² (Standard)	<input type="checkbox"/> WT (White)	<input type="checkbox"/> NL (No Lens)
	<input type="checkbox"/> -S (Square)	<input type="checkbox"/> TL (Trimless) <input type="checkbox"/> WC (Wood Ceiling)	<input type="checkbox"/> WT (White/) <input type="checkbox"/> BK (Black) <input type="checkbox"/> CN (Champagne) <input type="checkbox"/> SA (Satin Aluminum) <input type="checkbox"/> CC¹ (Custom Color)	<input type="checkbox"/> -PH (Pinhole) <input type="checkbox"/> -SP (Slot Pinhole) <input type="checkbox"/> -WW (Wall Wash) <input type="checkbox"/> -AL^{2,3} (Adjustable Lensed)	<input type="checkbox"/> BK (Black) <input type="checkbox"/> CA⁴ (Clear Alzak) <input type="checkbox"/> CN (Champagne) <input type="checkbox"/> SA (Satin Aluminum) <input type="checkbox"/> CC¹ (Custom Color)	<input type="checkbox"/> CL (Clear) <input type="checkbox"/> MP (Solite) <input type="checkbox"/> FR (Frosted)

1. Custom color only available for ST (Standard) Trim and ST (Standard), AL (Adjustable Lens) Reflectors only, contact CSL for details.
2. Wet Location rated when used with Additional Reflector Lens.
3. Must be ordered with corresponding Additional Reflector Lens.
4. CA (Clear Alzak) Finish only available for Round reflectors as ST (Standard) or AL (Adjustable Lens) styles.
5. Must be used with TL or WC trim style.



Acrobat™

DOWNLIGHTS



WET LOCATION

DAMP LOCATION

IC RATED

SSS AIRTIGHT



JA8 TITLE COMPLIANT 24 90 CRI OPTION ONLY

5 YEAR LIMITED WARRANTY

A Division of Troy-CSL Lighting, Inc.

14508 Nelson Avenue
City of Industry, CA 91744
P: 626.336.4511 • F: 626.330.4266

www.csllighting.com



C-CACR12-21

Copyright ©2022 Troy-CSL Lighting, Inc.

